

Max load:	n/a lb	n/a kg
Volume:	.34 cord of 8 ft	1.22 m ³
Area tip to tip:	5.40 ft ²	.50 m ²
Rotator lifting capacity:	25000 lb	11340 kg
Torque at relief pressure:	16150 lb-in	1825 Nm
	1450 psi	100 bars
Weight:	1350 lb	612 kg

Rotator	Maximum pressure: 5000 psi 345 bars	Recommended flow: 9 gpm 34 l/min
Rotator recommended flow will produce a maximum speed of 30 rpm		

Cylinder	Diameter	Recommended pressure	Pressure range	Flow range	Lock valves
Standard	3 " (76 mm)	4300 psi (296 bars)	3600-5000 psi (248-345 bars)	11-17 gpm (42-64 l/min.)	no
Standard	3 1/2 " (89 mm)	3000 psi (207 bars)	2500-3500 psi (172-241 bars)	16-25 gpm (61-95 l/min.)	no

Grapple cylinder maximum flow will theoretically produce a complete grapple open/close cycle in 4 seconds.

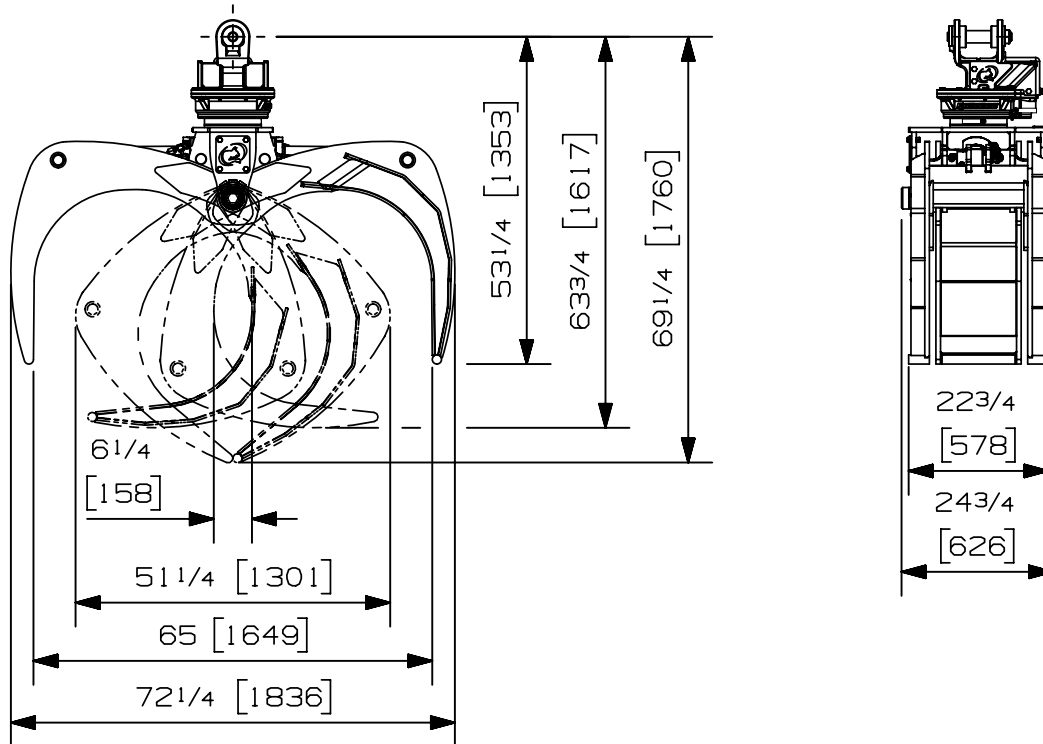

Options:

- Leveling plate (N/A)
- Load holding valve on cylinders (7 lbs / 3 kg)
-
-

web site: www.rotobec.com

email: rotobec@rotobec.com

Rotobec Inc.: Head office serving OEM's and Eastern Canada Ph: (418) 383-3002 Fax: (418) 383-5334
Rotobec West: Branch serving Western Canada and Western USA Ph: (250) 765-1161 Fax: (250) 765-0035
Rotobec USA: Branch serving Eastern and Central USA Ph: (603) 444-2103 Fax: (603) 444-0327

We reserve the right to change specifications and to improve our products without notice or obligation.

07006-7151
15/08/18 D.L.

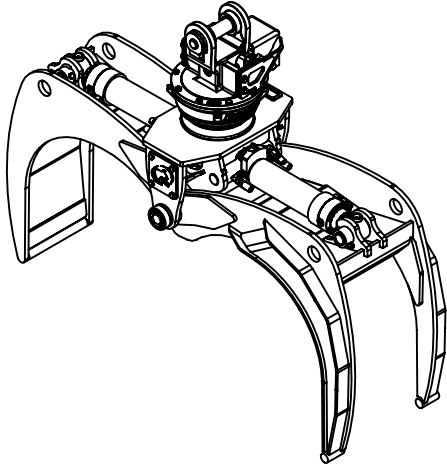

Max load:	n/a lb	n/a kg
Volume:	.34 cord of 8 ft	1.23 m ³
Area tip to tip:	5.40 ft ²	.50 m ²
Rotator lifting capacity:	32000 lb	14515 kg
Torque at relief pressure:	20160 lb-in	2278 Nm
	1810 psi	125 bars
Weight:	1395 lb	633 kg

Rotator	Maximum pressure: 5000 psi 345 bars	Recommended flow: 9 gpm 34 l/min
Rotator recommended flow will produce a maximum speed of 30 rpm		

Cylinder	Diameter	Recommended pressure	Pressure range	Flow range	Lock valves
Standard	3 " (76 mm)	4300 psi (296 bars)	3600-5000 psi (248-345 bars)	11-17 gpm (42-64 l/min.)	no
Standard	3 1/2 " (89 mm)	3000 psi (207 bars)	2500-3500 psi (172-241 bars)	16-25 gpm (61-95 l/min.)	no

Grapple cylinder maximum flow will theoretically produce a complete grapple open/close cycle in 4 seconds.

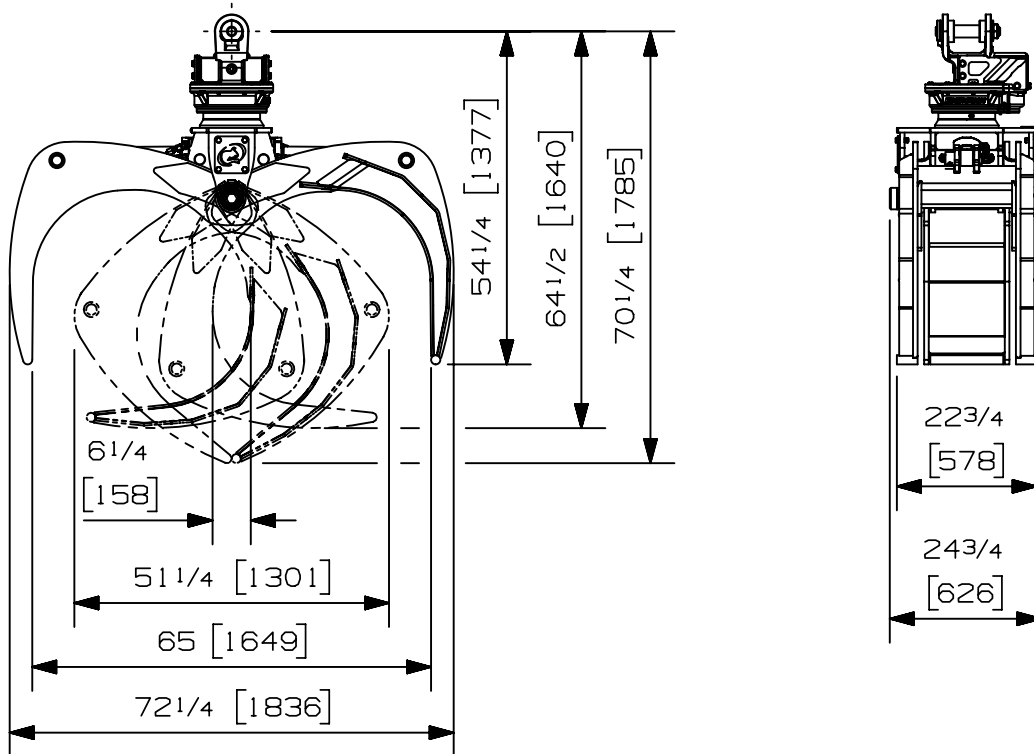

Options:

- Leveling plate (N/A)
- Load holding valve on cylinders (7 lbs / 3 kg)
-
-

web site: www.rotobec.com

email: rotobec@rotobec.com

Rotobec Inc.: Head office serving OEM's and Eastern Canada Ph: (418) 383-3002 Fax: (418) 383-5334
Rotobec West: Branch serving Western Canada and Western USA Ph: (250) 765-1161 Fax: (250) 765-0035
Rotobec USA: Branch serving Eastern and Central USA Ph: (603) 444-2103 Fax: (603) 444-0327

We reserve the right to change specifications and to improve our products without notice or obligation.

07006-3028
15/08/18 D.L.