

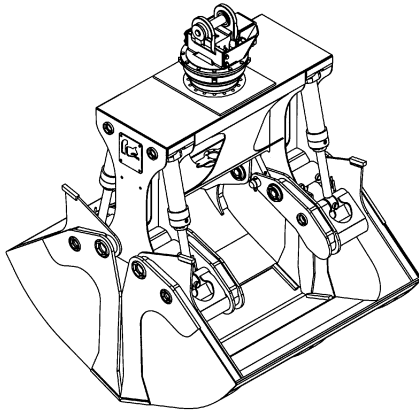

ROTOBEC™

Clamshell Bucket

CSB200 with rotator RT-502-STD



Opening	88 7/8 in. (2257 mm)	
Volume	2.00 cubic yards	1.53 cubic meters
Rotator lifting capacity	50000 lb (22680 kg)	
Torque at relief pressure	18630 in.lb (2105 Nm)	@ 1450 psi (100 bars)
Weight	4232 lb (1920 kg)	

Rotator	Maximum pressure: 5000 psi (345 bars)	Recommended flow: 9 gpm (34 l/min.)
Rotator recommended flow will produce a speed of 25 rpm.		

Cylinder	Diameter	Recommended pressure	Pressure range	Flow range	Lock valves
Standard	3" (76 mm)	3500 psi (241 bars)	2500 - 4500 psi (172 - 310 bars)	24 - 36 gpm (91 - 136 l/min.)	no

Grapple cylinder maximum flow will theoretically produce a complete grapple open/close cycle in 4 seconds.

Reference	Dimension
A	74 1/2 in. (1892 mm)
B	88 7/8 in. (2257 mm)
C	26 1/2 in. (673 mm)
D	92 3/4 in. (2356 mm)
E	62 in. (1575 mm)

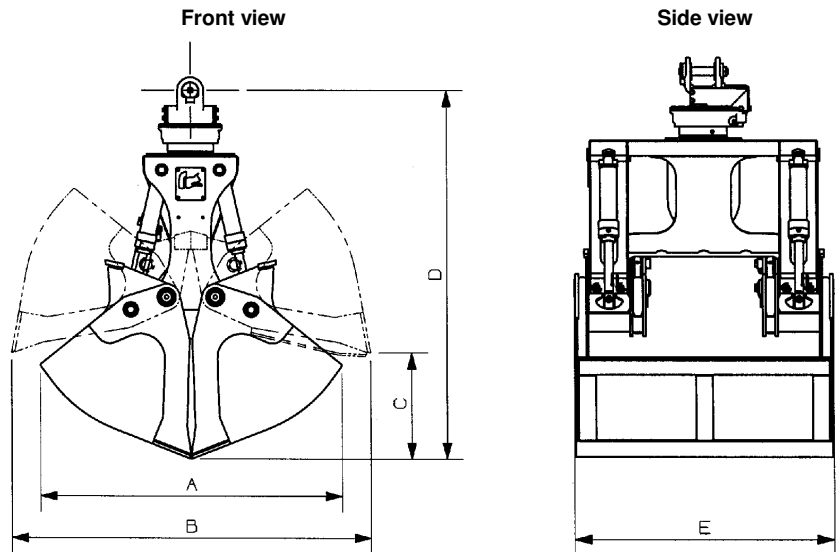

OPTIONS: Bolt-on cutting edges: 250 lb.

web site: www.rotobec.com

e-mail: rotobec@rotobec.com

Rotobec Inc.: Head office serving OEM's and Eastern Canada
 Rotobec West: Branch serving Western Canada and Western USA
 Rotobec USA: Branch serving Eastern and Central USA

Ph: (418) 383-3002 Fax: (418) 383-5334
 Ph: (250) 765-1161 Fax: (250) 765-0035
 Ph: (603) 444-2103 Fax: (603) 444-0327