

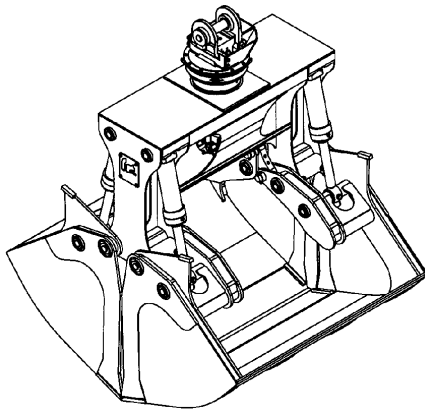

Clamshell Bucket

CSB400HD with rotator RT-1002-STD



Opening	110 1/2 in. (2807 mm)	
Volume	4.00 cubic yards	3.06 cubic meters
Rotator lifting capacity	100000 lb (45360 kg)	
Torque at relief pressure	22360 in.lb (2527 Nm)	@ 1450 psi (100 bars)
Weight	7172 lb (3253 kg)	

Rotator	Maximum pressure: 5000 psi (345 bars)	Recommended flow: 8 gpm (30 l/min.)
Rotator recommended flow will produce a speed of 20 rpm.		

Cylinder	Diameter	Recommended pressure	Pressure range	Flow range	Lock valves
Standard	4" (102 mm)	3500 psi (241 bars)	2500 - 4500 psi (172 - 310 bars)	37 - 50 gpm (136 - 189 l/min.)	no

Grapple cylinder maximum flow will theoretically produce a complete grapple open/close cycle in 6 seconds.

Reference	Dimension
A	93 3/4 in. (2381 mm)
B	110 1/2 in. (2807 mm)
C	34 1/4 in. (870 mm)
D	112 3/8 in. (2854 mm)
E	75 3/8 in. (1915 mm)

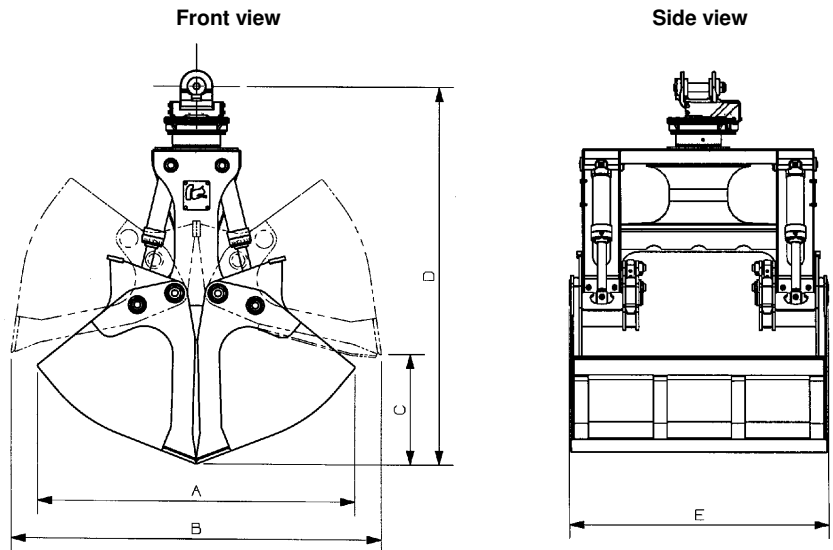

web site: www.rotobec.com

e-mail: rotobec@rotobec.com

Rotobec Inc.: Head office serving OEM's and Eastern Canada
 Rotobec West: Branch serving Western Canada and Western USA
 Rotobec USA: Branch serving Eastern and Central USA

Ph: (418) 383-3002 Fax: (418) 383-5334
 Ph: (250) 765-1161 Fax: (250) 765-0035
 Ph: (603) 444-2103 Fax: (603) 444-0327