

Max load:	- lb	- kg
Volume:	1.83 y ³	1.40 m ³
Area tip to tip:	- ft ²	- m ²
Rotator lifting capacity:	100000 lb	45359 kg
Torque at relief pressure:	22360 lb-in	2526 Nm
	1450 psi	100 bars
Weight:	5965 lb	2706 kg

Rotator	Maximum pressure: 5000 psi	345 bars	Recommended flow: 8 gpm	30 l/min
Rotator recommended flow will produce a maximum speed of 20 rpm				

Cylinder	Diameter	Recommended pressure	Pressure range	Flow range	Lock valves
Standard	3 1/2 " (89 mm)	4300 psi (296 bars)	3600 - 5000 psi (248-345 bars)	46 - 64 gpm (174-242 l/min.)	No

Grapple cylinder maximum flow will theoretically produce a complete grapple open/close cycle in 5 seconds.

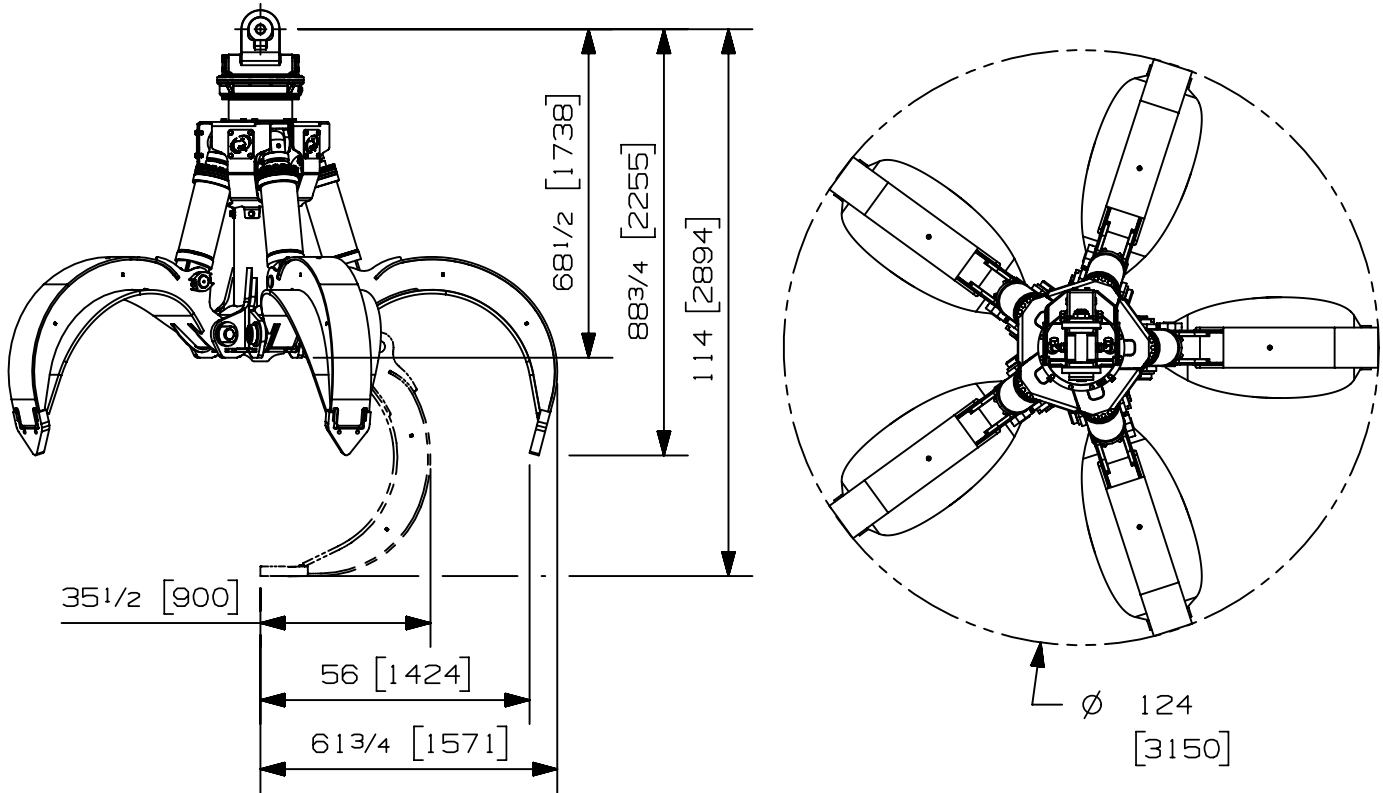

Options:

-
-
-
-

web site: www.rotobec.com

email: rotobec@rotobec.com

Rotobec Inc.: Head office serving OEM's and Eastern Canada Ph: (418) 383-3002 Fax: (418) 383-5334
Rotobec West: Branch serving Western Canada and Western USA Ph: (250) 765-1161 Fax: (250) 765-0035
Rotobec USA: Branch serving Eastern and Central USA Ph: (603) 444-2103 Fax: (603) 444-0327

We reserve the right to change specifications and to improve our products without notice or obligation.

07002-6599
12/02/2020 D.L.