

Max load:	- lb	- kg
Volume:	4.97 y ³	3.80 m ³
Area tip to tip:	- ft ²	- m ²
Rotator lifting capacity:	120000 lb	54431 kg
Torque at relief pressure:	51150 lb-in	5779 Nm
	1800 psi	124 bars
Weight:	11690 lb	5302 kg

Rotator	Maximum pressure: 5000 psi	345 bars	Recommended flow: 12 gpm	45 l/min
Rotator recommended flow will produce a maximum speed of 15 rpm				

Cylinder	Diameter	Recommended pressure	Pressure range	Flow range	Lock valves
Standard	4 " (102 mm)	4300 psi (296 bars)	3600 - 5000 psi (248-345 bars)	85 - 114 gpm (322-432 l/min.)	No

Grapple cylinder maximum flow will theoretically produce a complete grapple open/close cycle in 6 seconds.

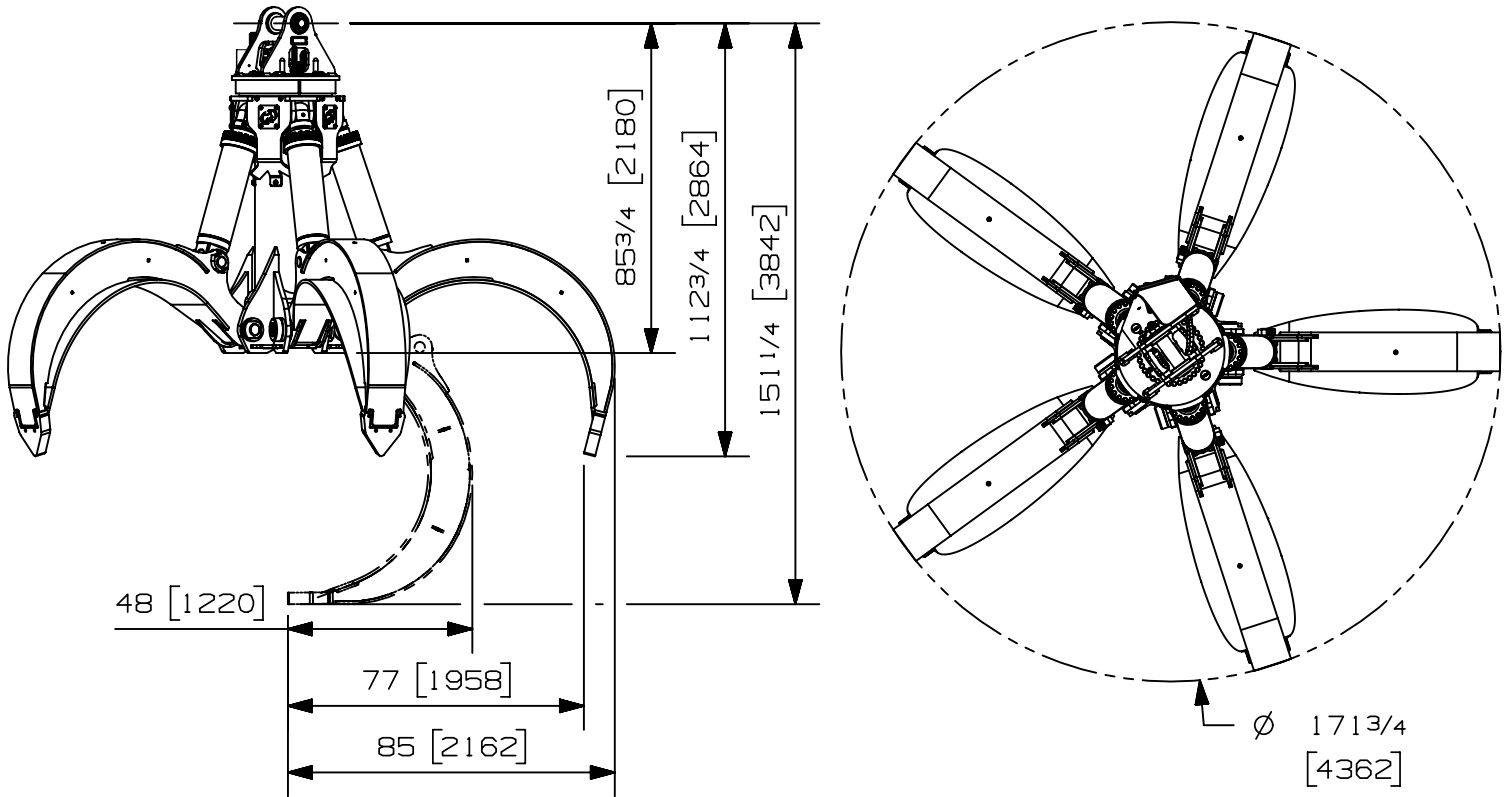

Options:

-
-
-
-

web site: www.rotobec.com

email: rotobec@rotobec.com

Rotobec Inc.: Head office serving OEM's and Eastern Canada Ph: (418) 383-3002 Fax: (418) 383-5334
Rotobec West: Branch serving Western Canada and Western USA Ph: (250) 765-1161 Fax: (250) 765-0035
Rotobec USA: Branch serving Eastern and Central USA Ph: (603) 444-2103 Fax: (603) 444-0327

We reserve the right to change specifications and to improve our products without notice or obligation.

07008-0740
18/02/20 D.L.